

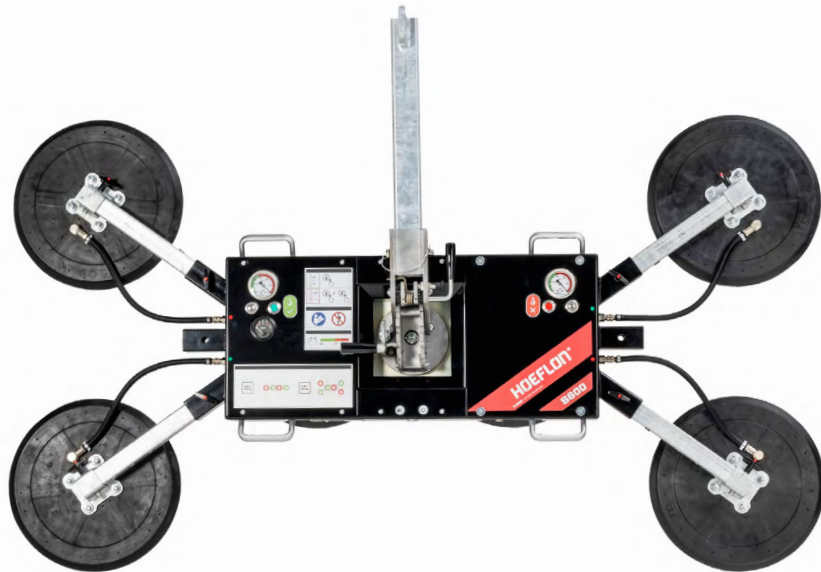

HOEFLON[®] S600 GLASS SUCTION LIFTER

S600

Specifications



Lifting capacity Dual Circuit:	300 / 450 / 600 kg
Machine weight:	54 / 63 / 70 kg
Rotation range:	360° with four locking positions
Tilting range:	90° with six locking positions
Machine height:	190 mm
Battery:	12VDC, 9Ah

S600

Specifications

The vacuum lifter for glass up to 600 kg. Equipped with double vacuum system as standard. The various configurations make this machine our all-rounder, suitable for projects small and large.

Unique features

- Compatible with spider and inline suction lifters
- Compact transport on trolley
- Machine weight: 85 - 100 kg
- Maximum lifting capacity: 600 kg

Delivered standard with:

- Remote control
- Transport trolley
- Long lifting arm
- Short lifting arm
- Swappable battery system incl. spare battery
- Protective covers for suction cups

Specifications

- Manual tilting with 6 locking positions and continuous adjustment
- Manual rotation with 4 locking positions
- Radio remote control of suction and release
- Interchangeable lifting point for lower overall height
- Transport trolley with pneumatic tyres

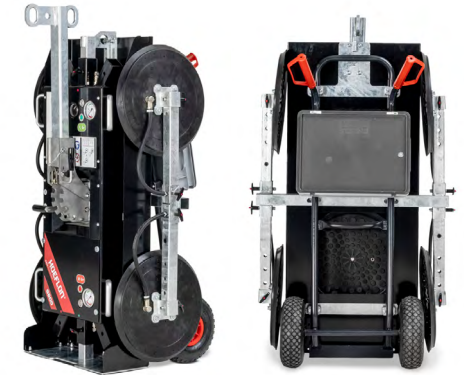

Accessories



Battery

Battery charger

Remote control

Lifting arm

300 kg - Compact

Single circuit

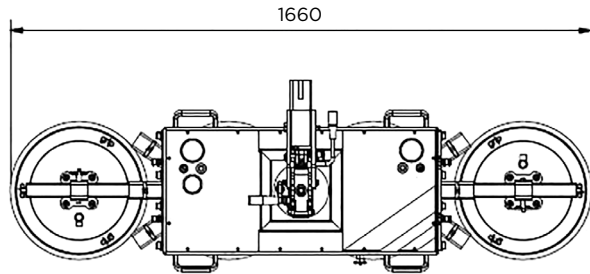

450 kg - Inline suction lifter, long

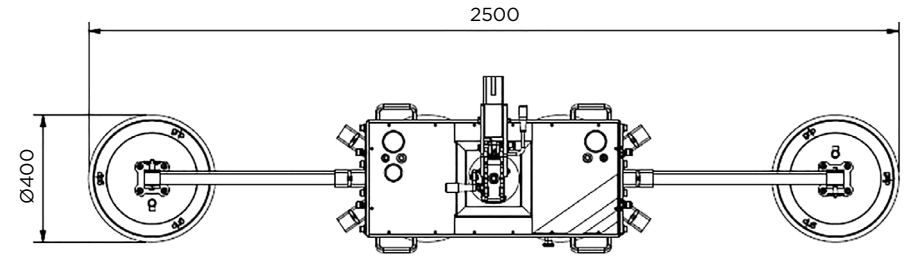

300 kg - Inline suction lifter

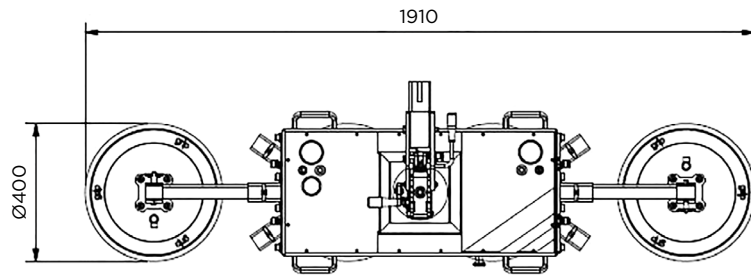

600 kg - Spider suction lifter

Short lifting arm

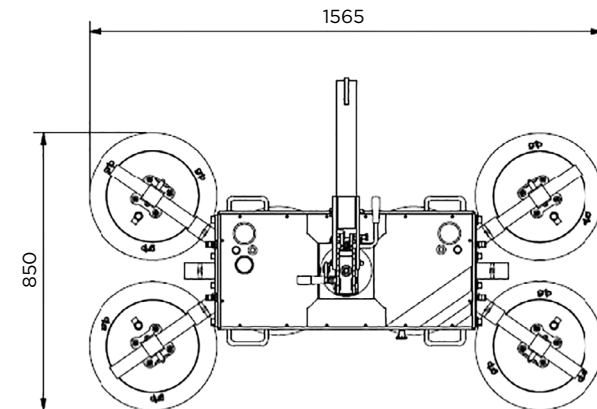

600 kg - Spider suction lifter

Long lifting arm

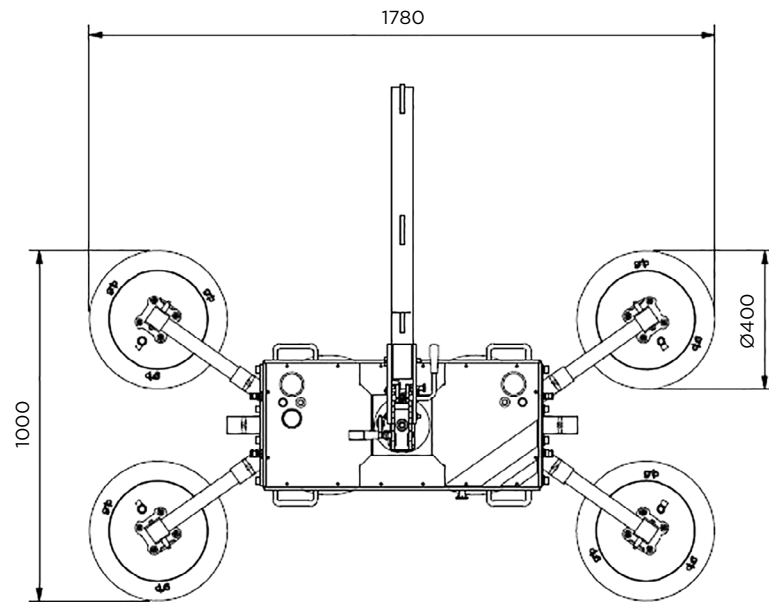

Hoeflon machines are functional and offer optimal power and reliability. We offer many possibilities and help you come up with solutions.

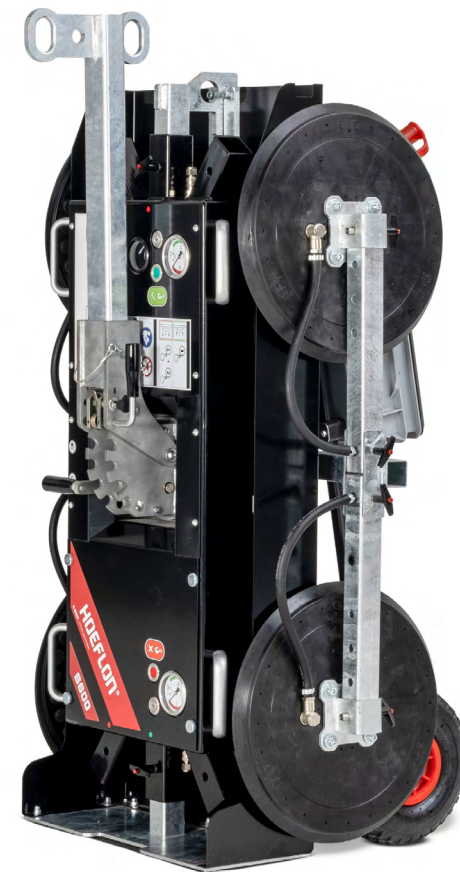

Monitor Lifts Training & Support



Operator Training



Service Training



24/7 Support



Service Trailer



UTE/Trucks









Service Training

Get In Touch

-  monitor.net.au
-  sales@monitor.net.au
-  1800 025 024 (free call)

Our Locations

-  **TAMWORTH**
143 Gunnedah Road, Tamworth NSW 2340
-  **SYDNEY**
9 Brumby Street, Seven Hills NSW 2147
-  **MELBOURNE**
75 Willandra Drive, Epping VIC 3076
-  **BRISBANE**
-  **CABOOLTURE**
2/2 Alta Drive, Caboolture QLD 4510
-  **PERTH**
-  **NEW ZEALAND**
Youngman Richardson & Co. Ltd.
Branches: Auckland, Wellington, Christchurch