



HOEFLON[®] C600 GLASS SUCTION LIFTER

C600 Specifications



Lifting capacity Single Circuit:	600 kg
Lifting capacity Dual Circuit:	300 kg
Rotation range:	Endless, with four locking positions
Tilting range:	90° with six locking positions
Machine weight:	30 kg
Suction cup dimensions:	800 x 480 mm
Machine height:	175 mm
Battery:	12VDC, 9Ah

C600 Specifications

The vacuum lifter for glass up to 600 kg. Standard equipped with double vacuum system for loads up to 300 kg. The machine itself weighs just 30 kg. The machine is optionally available with radio control and shortened lifting arm.

All our products are designed in close cooperation with users from the field. This results in products that are a class apart when it comes to the details and provide the user with every convenience in daily use.

Unique features

- Can easily be taken out of and put back in vehicle by one person
- Lightweight vacuum lifter with double-circuit
- Machine weight: 30 kg
- Maximum lifting capacity: 300 / 600 kg

Delivered standard with:

- Remote control
- Transport trolley
- Short lifting arm
- Swappable battery system incl. spare battery

Accessories

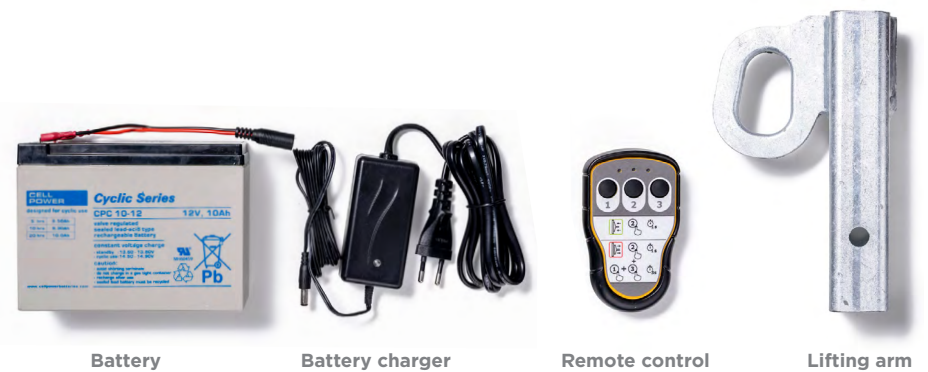

Battery

Battery charger

Remote control

Lifting arm

Specifications

- Angle adjustment specially intended for interior glazing
- Rotation with four locking positions
- Radio remote control of suction and release
- Short lifting arm for interior glazing
- Transport trolley with pneumatic tyres

Dimensions

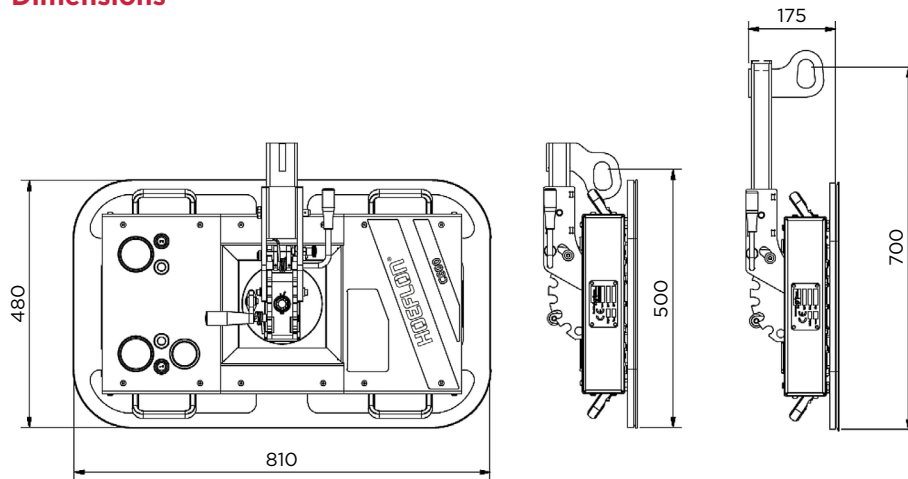

Hoeftlon machines are functional and offer optimal power and reliability. We offer many possibilities and help you come up with solutions.



Monitor Lifts Training & Support



Operator Training



Service Training



24/7 Support



Service Trailer



UTE/Trucks









Service Training

Get In Touch

-  monitor.net.au
-  sales@monitor.net.au
-  1800 025 024 (free call)

Our Locations

-  **TAMWORTH**
143 Gunnedah Road, Tamworth NSW 2340
-  **SYDNEY**
9 Brumby Street, Seven Hills NSW 2147
-  **MELBOURNE**
75 Willandra Drive, Epping VIC 3076
-  **BRISBANE**
-  **CABOOLTURE**
2/2 Alta Drive, Caboolture QLD 4510
-  **PERTH**
-  **NEW ZEALAND**
Youngman Richardson & Co. Ltd.
Branches: Auckland, Wellington, Christchurch